

UET



## **CONTROL UNIT FOR THE AIR HEATING UNIT WITH ELECTRIC HEATER AOE SERIES**

## CONTENTS

Safety Requirements	3
Introduction	5
Use	5
Delivery Package	5
Designation Key	5
Technical Data	5
Design and Operating Logic	7
Installation and Setup	7
Connection to power mains	9
Technical Maintenance	14
Troubleshooting	14
Transportation and Storage Rules	14
Manufacturer's Warranty	15
Acceptance Certificate	16
Vendor's Information	16
Installation Certificate	16
Warranty Card	17

**SAFETY REQUIREMENTS**

- Read the user's manual carefully prior to the operation and installation of the control unit.
- Installation and operation of the control unit shall be performed in accordance with the present user's manual as well as the provisions of all the applicable local and national construction, electrical and technical codes and standards.
- The warnings contained in the present user's manual must be considered most seriously since they contain vital personal safety information.
- Failure to follow the safety regulations may result in an injury or control unit damage.
- Read the manual carefully and keep it as long as you use the control unit.
- While transferring the unit control the user's manual must be turned over to the receiving operator.

Symbol legend used in the manual:



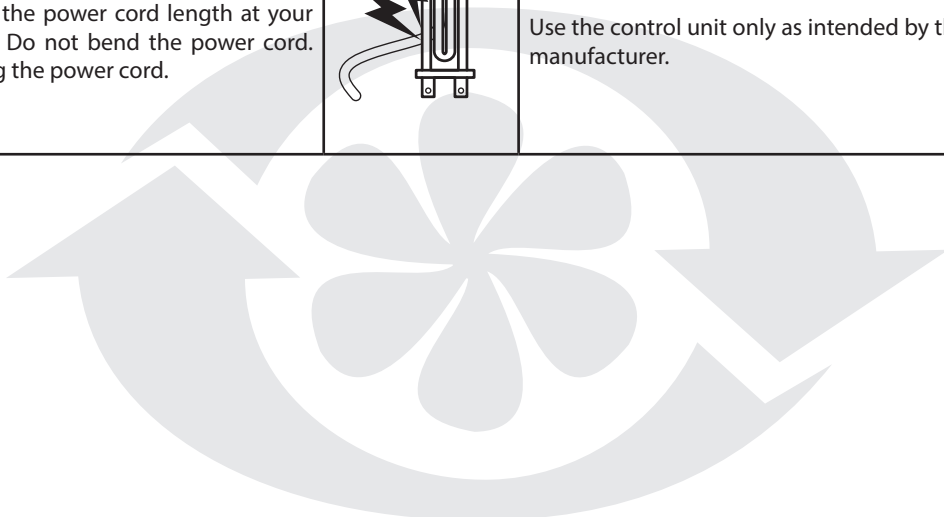

	<b>ATTENTION!</b>
	<b>RESTRICTED!</b>

**CONTROL UNIT INSTALLATION - SAFETY PRECAUTIONS**

	The control unit must be disconnected from the power supply prior to every installation or repair operation.		Ground the control unit!
	The control unit must not be operated outside the temperature range stated in the user's manual or in aggressive or explosive environments.		Do not use damaged equipment or conductors to connect the control unit to power mains.
	While installing the control unit follow the safety regulations specific to the use of electric tools.		Unpack the control unit with care.
	Do not change the power cord length at your own discretion. Do not bend the power cord. Avoid damaging the power cord.		Use the control unit only as intended by the manufacturer.

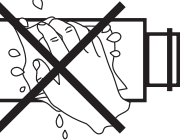
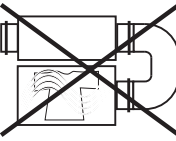
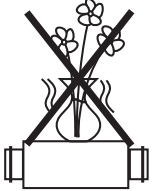

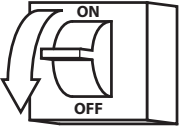
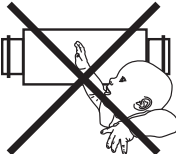
## CONTROL UNIT OPERATION - SAFETY PRECAUTIONS

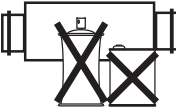
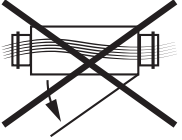
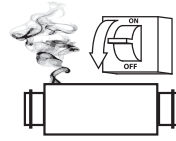
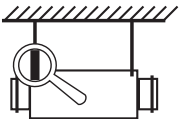
	<p>Do not touch the controller or the remote control with wet hands. Do not carry out the control unit maintenance with wet hands.</p>		<p>Do not wash the control unit with water. Protect the control unit electric parts from water ingress.</p>
	<p>Use the control unit only as intended by the manufacturer. Do not connect any cloth dryers or any other equipment to the ventilation system.</p>		<p>Do not put any water containers (e.g. vases etc.) on top of the control unit.</p>
	<p>Do not sit on the control unit or put any foreign objects on top of it.</p>		<p>Disconnect the control unit from the power mains prior to any technical maintenance.</p>
	<p>Do not let children operate the control unit.</p>		<p>Keep the power cord intact while operating the control unit. Do not put any foreign objects on top of the power cord.</p>
	<p>Keep explosive and inflammable products away of the control unit.</p>		<p>Do not open the operating control unit.</p>
	<p>In case of unusual sounds, smoke disconnect the control unit from power supply and contact the service centre.</p>		<p>Do not let air flow from the control unit be directed to the open flame devices or candles.</p>

## INTRODUCTION

The present User's Manual combined with the technical details, the Operation Manual and the Product Certificate contains the information specific to the operation and installation of the VENTS AOE series electric warm air heater control unit (UET) (hereinafter «Control Unit»).

## USE

The Control Unit is designed for automatic control of VENTS AOE series electric warm air heater operation.



**THE CONTROL UNIT IS NOT INTENDED FOR OPERATION BY CHILDREN OR ANY PERSONS WITH LIMITED SENSORY OR MENTAL CAPACITY AS WELL PERSONS LACKING THE REQUIRED TRAINING. THE CONTROL UNIT MUST BE HANDLED ONLY BY PROPERLY QUALIFIED PERSONNEL AFTER THE APPROPRIATE SAFETY BRIEFING. THE CHOICE OF CONTROL UNIT INSTALLATION LOCATION MUST PREVENT UNAUTHORIZED ACCESS BY UNATTENDED CHILDREN.**

## DELIVERY PACKAGE

- Control Unit - 1 piece.
- User's Manual - 1 piece.
- Shipping Box - 1 piece.

## DESIGNATION KEY

**UET - X D**

### Automation Equipment Options

- E - single-phase
- D - three-phase

### Air Heating Unit Power

- 15 - Up to 15 kW
- 30 - Up to 30 kW

### Designation

**UET** - control unit for the electric heater

## TECHNICAL DATA

The control unit is designed for operation in an enclosed area at ambient temperatures from 0 °C to + 35 °C at relative humidity of up to 80% (at +25 °C).

The units meet the requirements of IP44 hazardous parts access and water ingress protection standard.

The units belong to electrical shock hazard protection class I.

The main outside and connecting dimensions as well as the appearance and technical parameters of the unit are given on Figure 1 and in Table 1. The control unit undergoes continuous improvement - therefore, some models may slightly differ from the ones described herein.

Table 1. Technical Data

Parameter		UET-15D	UET-30D
AOE Air Heating Unit Compatibility		AOE 9 AOE 12 AOE 15	AOE 18 AOE 24 AOE 30
Supply Voltage, 50 Hz [V]		3 ~ 400	
Nominal Voltage Supplied to Fan Motor [V]	High Speed (H)	230±10%	
	Medium Speed (M)	170±10%	
	Low Speed (L)	130±10%	
Fan Motor Maximum Current [A]		1,3	
Maximum three-phase electric power input [kW]		up to 15	up to 30
Air Temperature at Heater Outlet [°C]		40±2	
Weight [kg]		5	6

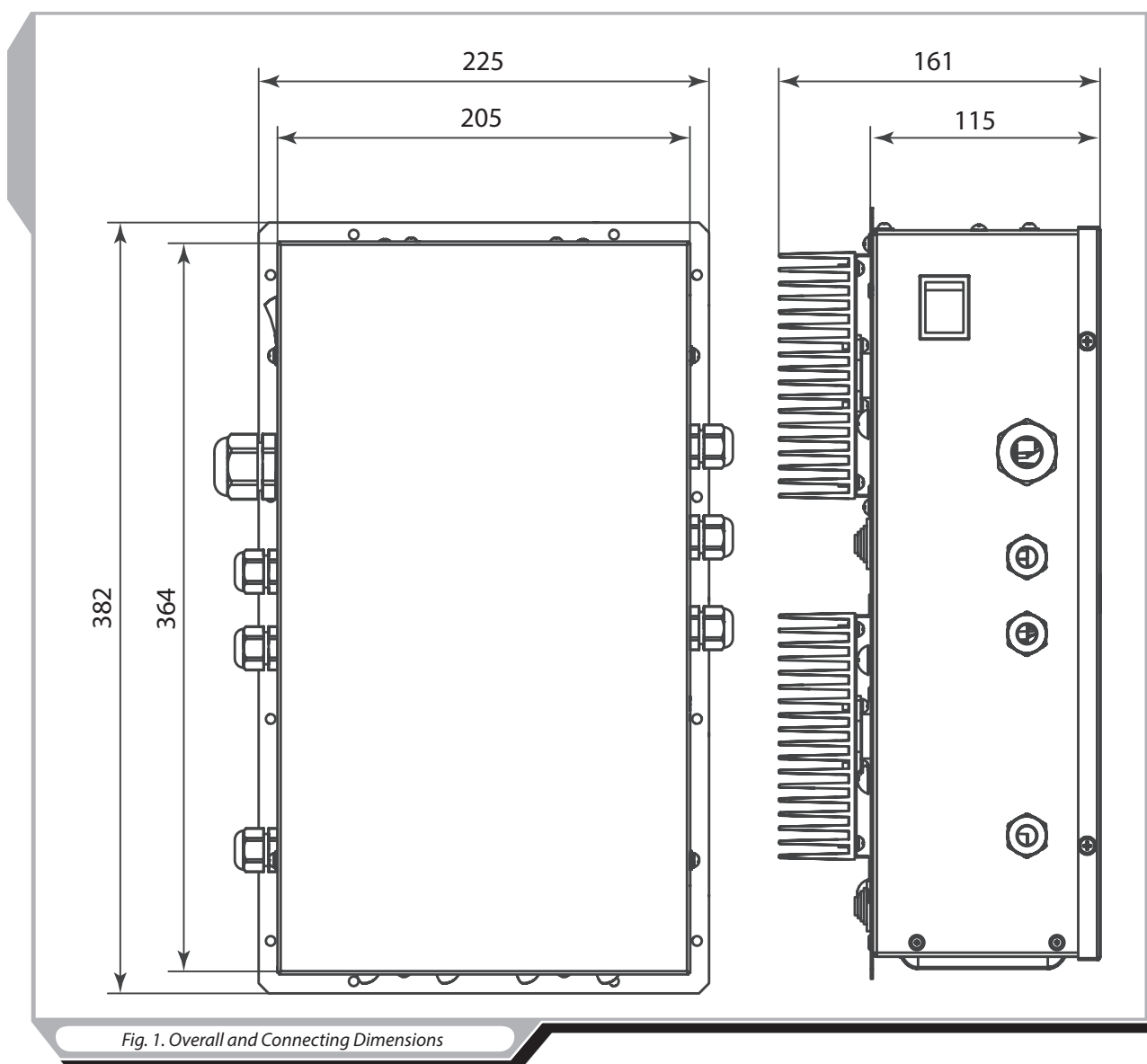

## DESIGN AND OPERATING LOGIC

The control unit is protected with a metal casing (Fig. 1 and 2). The control unit is activated and deactivated by means of the switch with an indicator light installed on the side panel. The power leads are routed into the control unit through sealed lead-ins. The wires are connected to the terminal blocks according to the connections diagram. The unit is equipped with resettable fuses for short-circuit protection and an electric motor fuse.

The single-phase electric motor operation mode is selected by means of the knob on the control unit casing allowing single-speed or triple-speed operation. The fan speed is controlled by means of the TRIAC regulator. The electric heater output is controlled by means of the dedicated TRIAC regulator. The air stream temperature adjustment algorithm is based on the heater activation/deactivation time (full power) control depending on the dialed heating requirements.

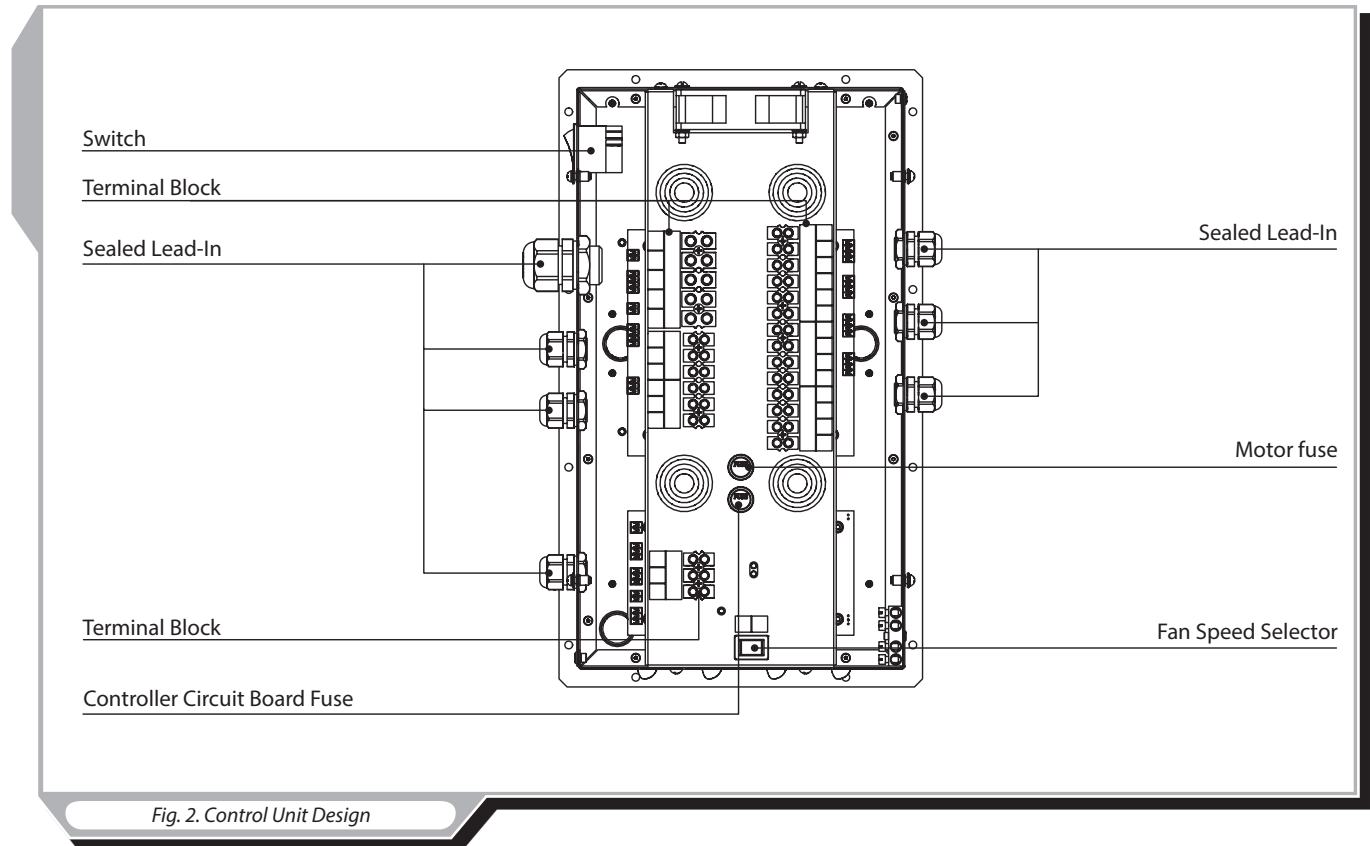

## INSTALLATION AND SETUP

**Having unpacked the control unit and prior to the installation:**

- Carefully read the instructions specific to the control unit installation, operation and maintenance;
- Check for signs of transit damage;
- Check for any foreign objects which may have penetrated into the unit casing.

Follow the safety regulations during the make-ready procedures and control unit operation.

### Control Unit Installation.

Secure the control unit to the AOE warm air heater in the vertical position as shown on Fig. 3.

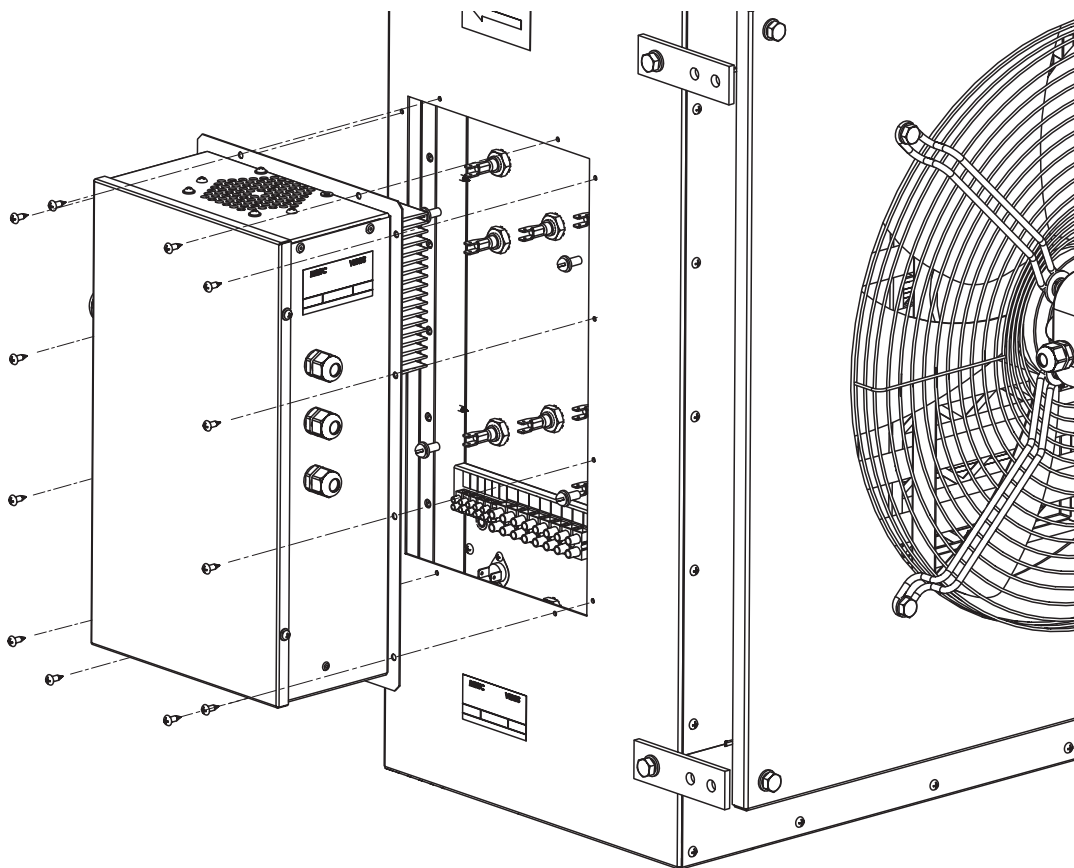

Fig. 3. Control Unit Installation

### Digital Thermostat Installation.

The Control Unit is operated in combination with the indoor digital thermostat (not included in delivery package) of the following two types: RTS-1-400 (RTSD-1-400) and TST-1-300 (TSTD-1-300) (Fig. 4). Since the digital thermostat controls the warm air heater operation mode it must be installed on the premises being served by the warm air heater. The digital thermostat is designed for indoor wall mounting. The digital thermostat should be installed at the height of 1.5 m from the floor level. To ensure correct operation of the warm air heater the thermostat should not be installed near windows, doors as well as heating and cooling equipment (Fig. 5).



**RTS - 1 - 400**  
**RTSD - 1 - 400**

(with remote-positioned control panel)



**TST - 1 - 300**  
**TSTD - 1 - 300**

(with remote-positioned control panel)

Fig. 4. Digital Thermostats



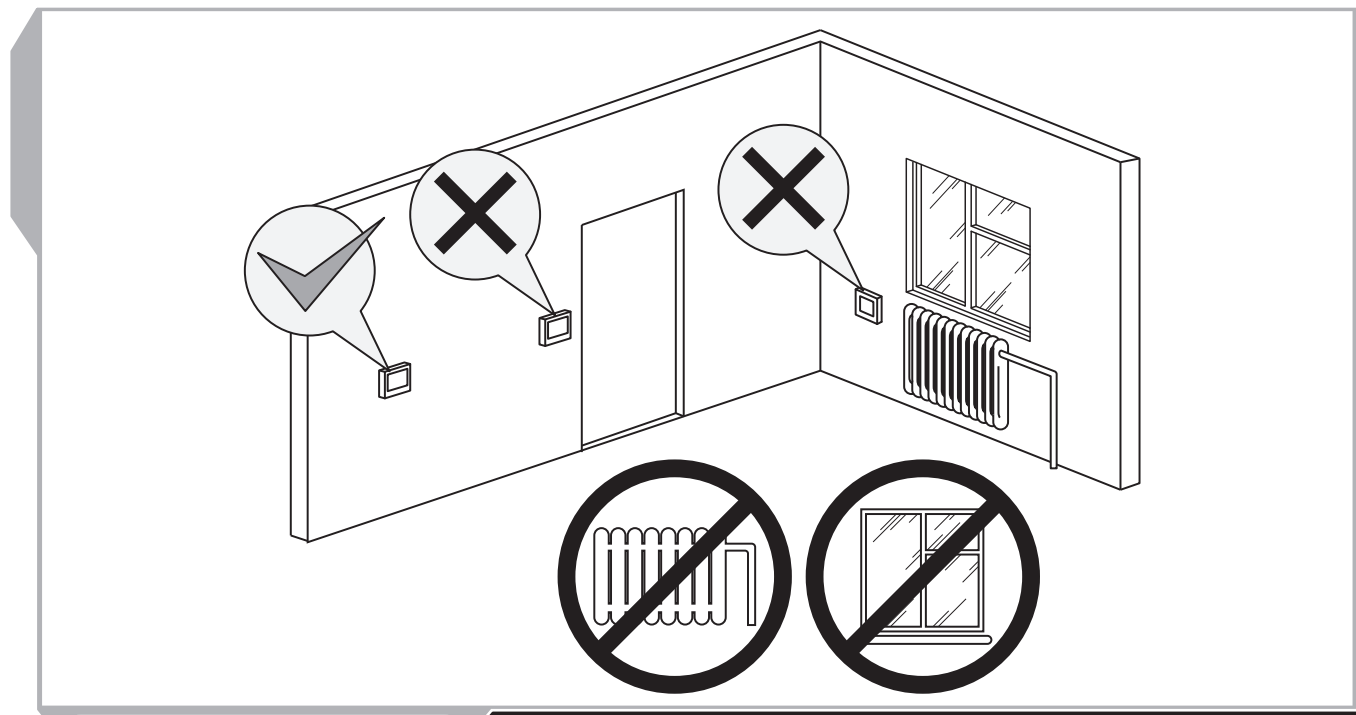

Fig. 5. Digital Thermostat Installation

#### CONNECTION TO POWER MAINS



**DISCONNECT THE WARM AIR HEATER FROM THE POWER MAINS PRIOR TO ANY ELECTRICAL WORK. THE CONTROL UNIT MUST BE CONNECTED TO THE POWER MAINS BY A PROFESSIONAL ELECTRICIAN QUALIFIED FOR UNASSISTED OPERATIONS WITH ELECTRICAL INSTALLATIONS UP TO 1,000 V AFTER BEING MADE FAMILIAR WITH THE PRESENT OPERATION MANUAL. THE NOMINAL ELECTRICAL PARAMETERS OF THE CONTROL UNIT ARE STATED ON THE FACTORY STICKER. ANY TAMPERING WITH THE INTERNAL CONNECTIONS IS PROHIBITED AND WILL VOID THE WARRANTY.**



**THE CONTROL UNIT MUST BE CONNECTED TO THE EARTH LOOP!**

The control unit is designed for connection to 400 V / 50 Hz three-phase AC mains.

The control unit connections (cables and wires) must be durable, insulated and heat-resistant. The external lead-in must be equipped with an automatic cutout switch built into the stationary wiring to disconnect all the power mains phases. The external switch position must ensure free access for quick power-off of the unit.

The recommended automatic switch nominal current should be based on the specific AOE air heating unit. The recommended conductor section and automatic switch nominal current values are given in Table 2. However, the conductor selection shall be based on the maximum permissible wire heating depending on the wire type, its insulation, length and installation method (i.e. overhead, in pipes or inside the walls).

Table 2. Recommended Automatic Switch Nominal Current and Conductor Section Values

Name of the air heating unit	Automatic Switch Current [A]	Conductor Number and Section [mm <sup>2</sup> ]
AOE-9	20	5x2,5
AOE-12	25	5x2,5
AOE-15	31,5	5x4,0
AOE-18	40	5x6,0
AOE-24	50	5x10,0
AOE-30	63	5x10,0

**Control Unit Connection.**

Remove the control unit lid. Route the power leads into the unit through the sealed lead-ins. The external electrical conductors are connected to the air heating unit via bolt-down terminals.

The fan motor is powered through the K1 cable of which one end is connected to the UET at the factory and the other routed outside through the lower right sealed lead-in (Fig. 2). The wires on the outside end of the K1 cable have terminals for connection to the fan motor screw terminal block. The K1 cable connection to the fan motor is shown in Table 3.

*Table 3. Control Unit Connection*

Cable Wire Markings	Circuit	Motor Connection Circuit
"1"	U1	L
"2"	U2	N
Yellow and Green	PE	PE
"3"	Z	Z

**The earth clamp must be connected to the earth loop!**

Select the single-speed or the triple-speed operation mode by setting the fan speed selector to «V1» or «»3» correspondingly (Fig. 1). Complete the electrical connections according to the diagram (Fig. 6-9). To connect the unit according to the diagram shown on Fig. 7 and Fig. 9 remove the jumper No. 68 between contacts X2.1 («L») and X4.1 («L1»).

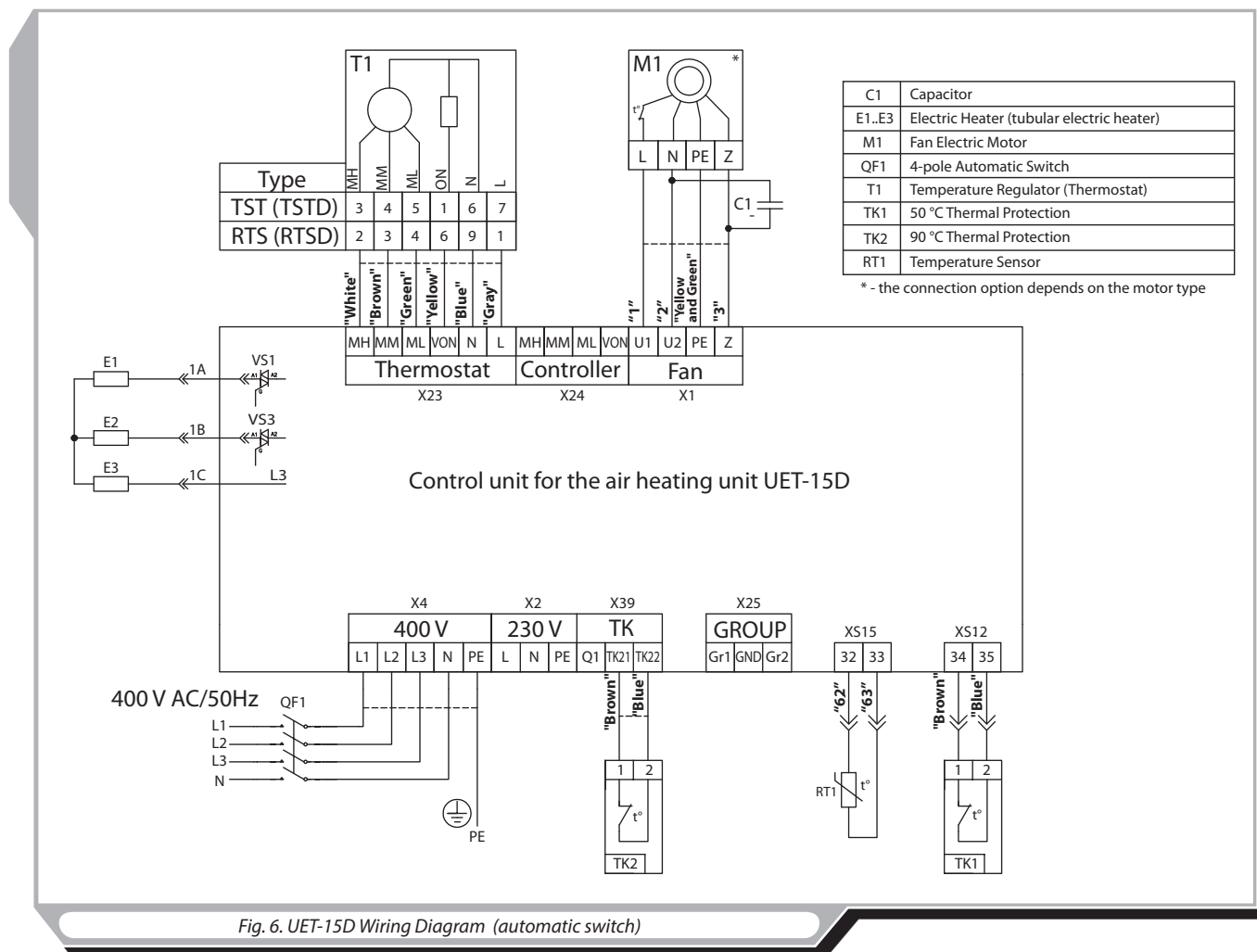

Fig. 6. UET-15D Wiring Diagram (automatic switch)

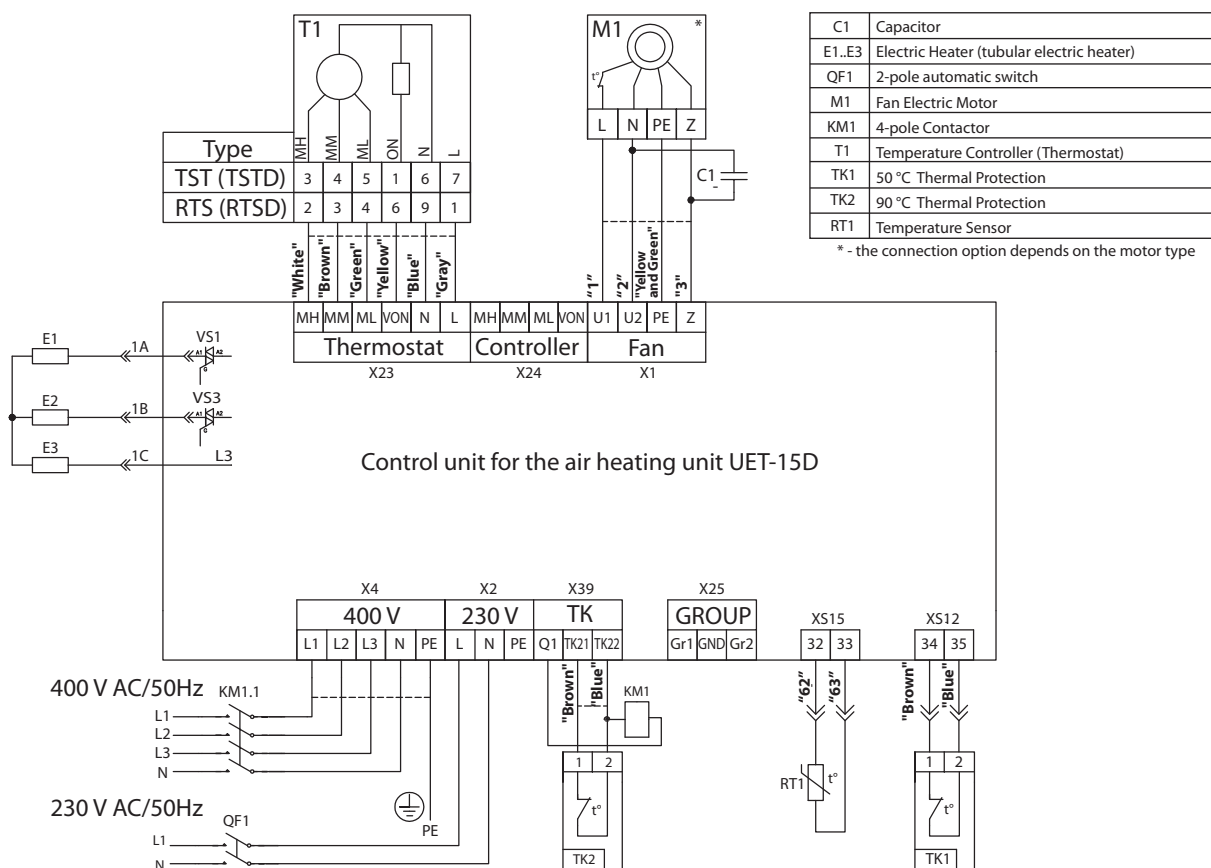

Fig. 7. UET-15D Connection Diagram (electromagnetic contactor)

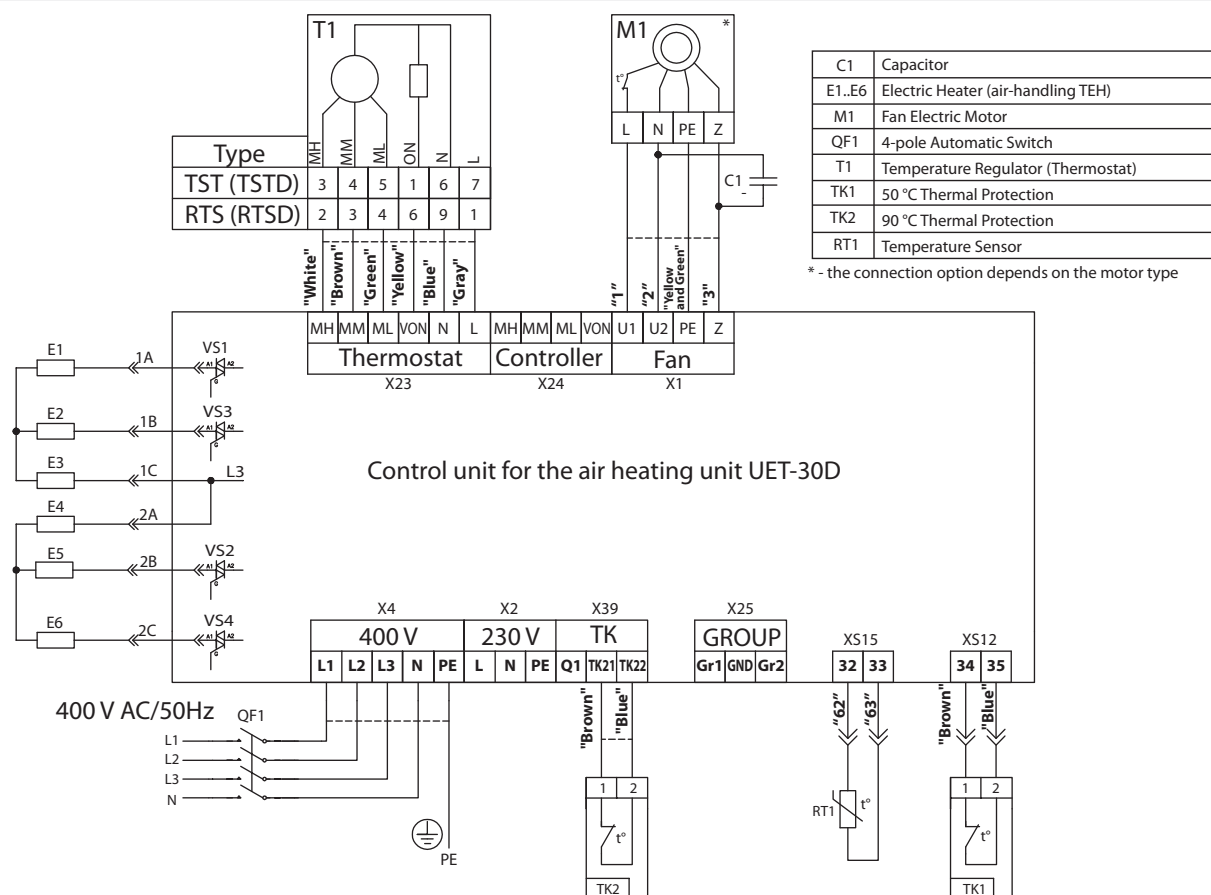

Fig. 8. UET-30D Connection Diagram (automatic switch)

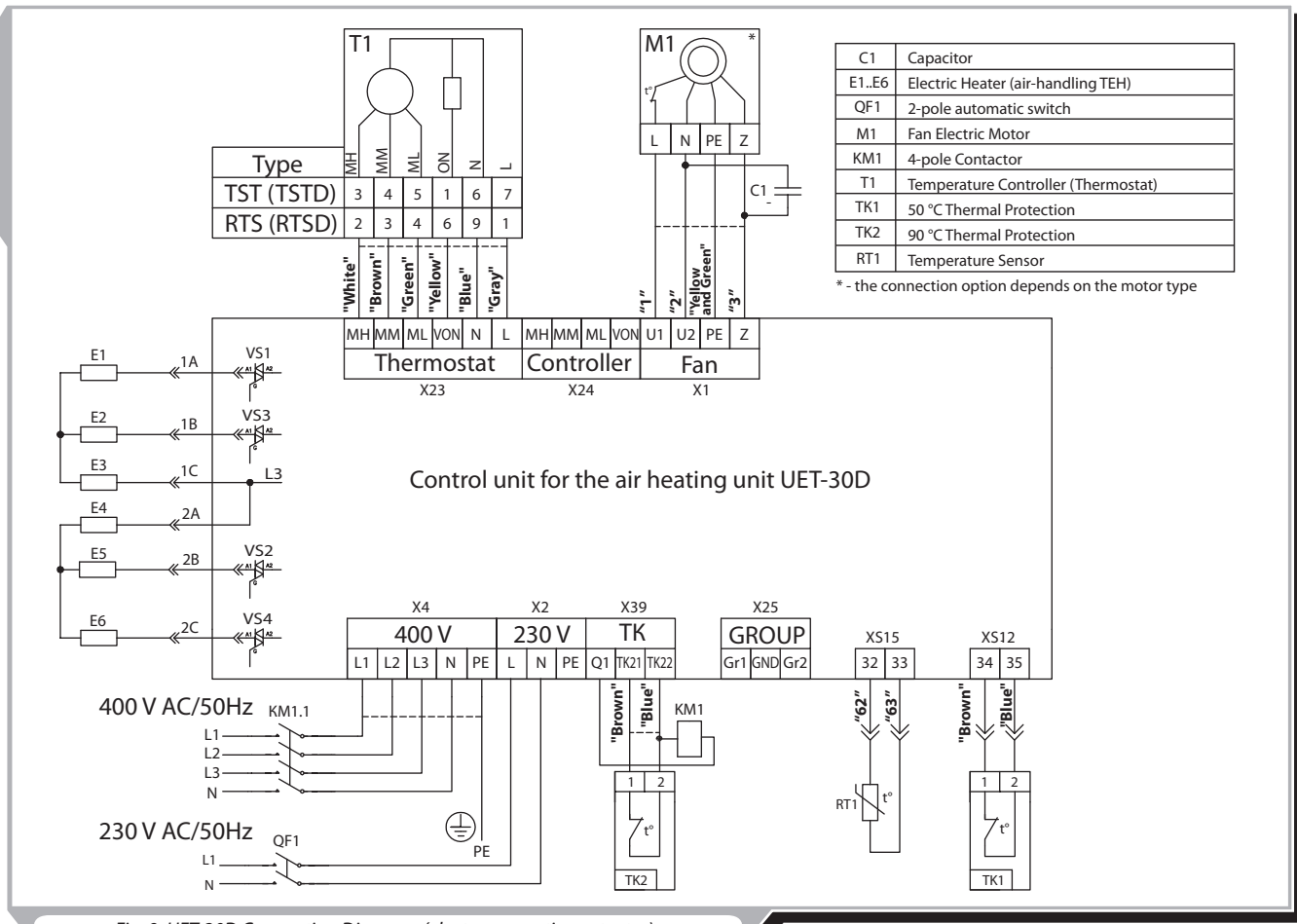

Fig. 9. UET-30D Connection Diagram (electromagnetic contactor)

**Digital Thermostat Connection.**

The thermostat is connected via the K2 cable of which one end is connected to the UET at the factory and the other routed outside through the upper right sealed lead-in (Fig. 2). The wires on the outside end of the K1 cable have terminals for connection to the thermostat screw terminal block. The K2 cable connection to the thermostat is shown in Table 4.

Table 4. Thermostat Connection

Cable Wire Markings	Circuit	Thermostat Connection Circuit	
		RTS (RTSD)	TST (TSTD)
Gray	L	1	7
Blue	N	9	6
White	MH	2	3
Brown	MM	3	4
Green	ML	4	5
Yellow	VON	6	1

The control unit allows using the same digital thermostat to control several heating units (Fig. 10). Such solution is recommended when several heating units are used for thermal conditioning of the same premises. The same digital thermostat must not be used to simultaneously control more than 10 heating units while using connector cables of 0.75 mm<sup>2</sup> in cross-section and maintaining the total length of interconnected segments below 400 m. The connection diagram is given on Fig. 11.

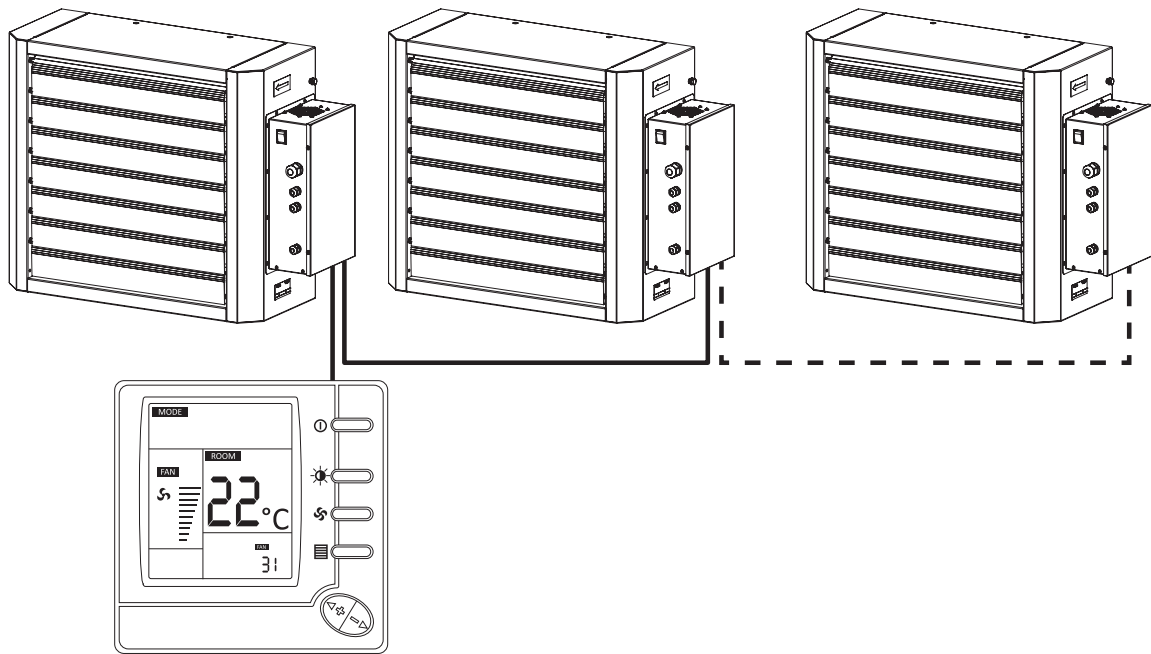

Fig. 10. Series Connection of Several Units

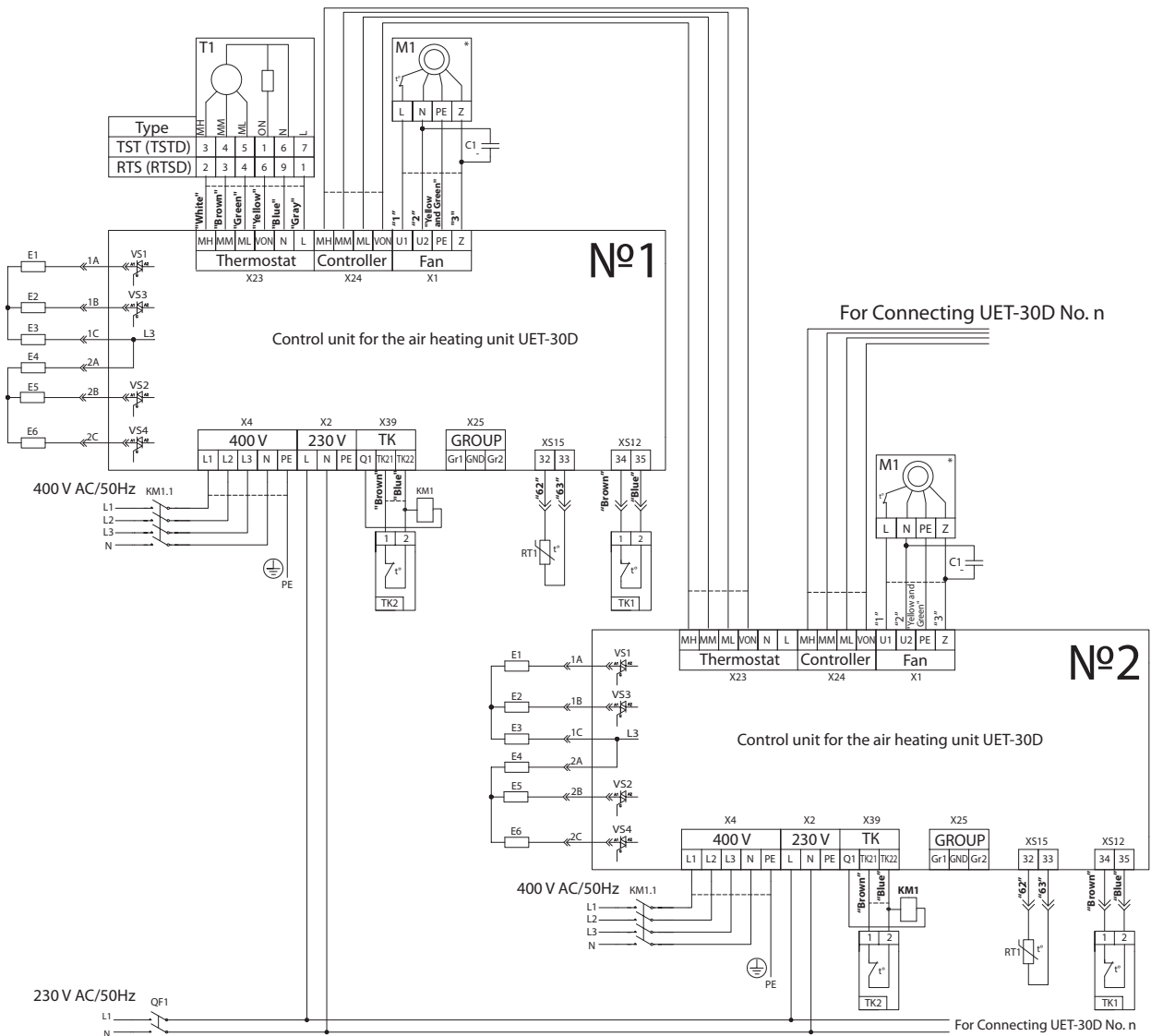

Fig. 11. Schematic Diagram for Connecting Several UET-30D Control Units

Engage the switch (Fig. 2) to power up the unit, switch the thermostat to the desired mode (see the Operation Manual for the specific thermostat type) and start the unit up. After the startup the unit operates automatically. To shut the unit down follow the start-up procedure in the reverse order. Switch off the thermostat, let the fan come to a complete halt (upon the thermostat deactivation the fan will run for two more minutes to blow the tubular electric element), then shut the unit down with the switch after the complete stop.

### TECHNICAL MAINTENANCE

The technical maintenance and repair of the control unit may commence only after its disconnection from the power mains.

Prior to putting the unit into operation and at least every month thereon check the for any loose wires, cables, threaded joints and terminal connections. If necessary, tighten the connections avoiding damage which may impair further operation of the unit. From time to time clean the air vents of the control unit from dust and dirt. The control unit maintenance must be performed by qualified personnel after familiarization with the unit operation and design, undergoing the appropriate safety briefing and obtaining the work order authorization.

### TROUBLESHOOTING

Table 5. Possible Malfunctions and Their Elimination

Problem	Possible Reasons	Elimination Method
Control unit will not start	The unit is not connected to the power mains.	Make sure that the unit is properly connected to the power mains and make any corrections, if necessary.
	Loose terminal connections	Switch off the control unit. Check for any loose cables in the terminals.
The automatic breaker activates upon the unit power-up	Excessive electric current consumption caused by a short circuit.	Switch off the control unit. Contact the service centre.

### STORAGE AND TRANSPORTATION RULES

Store the control unit in the manufacturer's original packing box in a dry ventilated premise at the temperatures from +1°C up to +40°C. Storage environment must not contain aggressive vapours and chemical mixtures provoking corrosion, insulation and sealing deformation.

Use hoist machinery for handling and storage operations to prevent the control unit damage in consequence of falling or excessive oscillation.

Fulfil the handling requirements applicable for the applicable freight type. Transportation with any vehicle type is allowed provided that the control unit is protected against mechanical and weather damage.

Avoid any mechanical shocks and strokes during handling operations.

**MANUFACTURER'S WARRANTY**

The manufacturer hereby warrants normal operation of the control unit over the period of 24 months from the retail sale date provided the user's observance of the transportation, storage, installation and operation regulations. Should any malfunctions occur during the control unit operation through the manufacturer's fault during the warranty period the user is entitled to elimination of faults by means of warranty repair performed by the manufacturer. The warranty repair includes work specific to elimination of faults in the control unit operation to ensure its intended use by the user within the warranty period. The faults are eliminated by means of replacement or repair of the complete unit or the faulty part thereof.

**The warranty repair does not include:**

- Routine maintenance;
- Control unit installation / dismantling;
- Control unit setup.

To benefit from warranty repair the user must provide the unit, the user's manual with stamped sale date and the payment document certifying the purchase. The control unit model must comply with the one stated in the user's manual.

**Contact your Seller for warranty service.****The manufacturer's warranty does not apply to the following cases:**

- User's failure to provide the control unit with the entire delivery package as stated in the user's manual or with missing component parts previously dismounted by the user;
- Mismatch of the control unit model and make with the respective details stated on the control unit packing and in the user's manual;
- User's failure to ensure timely technical maintenance of the control unit;
- External damage to the casing (excluding external modifications of the control unit as required for its installation) and the internal components of the control unit;
- Alteration of the control unit design or engineering changes of the control unit;
- Replacement and use of the control unit assemblies, parts and components not approved by the manufacturer;
- Control unit misuse;
- User's violation of the unit installation regulations;
- User's violation of the control unit management regulations;
- Control unit connection to the power mains with a voltage different from the one stated in the user's manual;
- Control unit breakdown due to voltage surges in the power mains;
- User's discretionary repair of the control unit;
- control unit repair performed by any persons without the manufacturer's authorization;
- Expiry of the unit warranty period;
- User's violation of the established regulations specific to the control unit transportation;
- User's violation of the control unit storage regulations;
- Wrongful acts against the control unit committed by third persons;
- control unit breakdown due to circumstances of insuperable force (fire, flood, earthquake, war, hostilities of any kind, or blockade);
- Missing seals if provided by the user's manual;
- Failure to provide the user's manual with the sale date stamp;
- Missing payment document certifying the control unit purchase.



**FOLLOWING THE REGULATIONS STIPULATED HEREIN WILL ENSURE A LONG AND TROUBLE-FREE OPERATION OF THE CONTROL UNIT.**



**USERS' CLAIMS SHALL BE SUBJECT TO REVIEW ONLY UPON PRESENTATION OF THE CONTROL UNIT, THE PAYMENT DOCUMENT AND THE USER'S MANUAL WITH THE SALE DATE STAMP.**

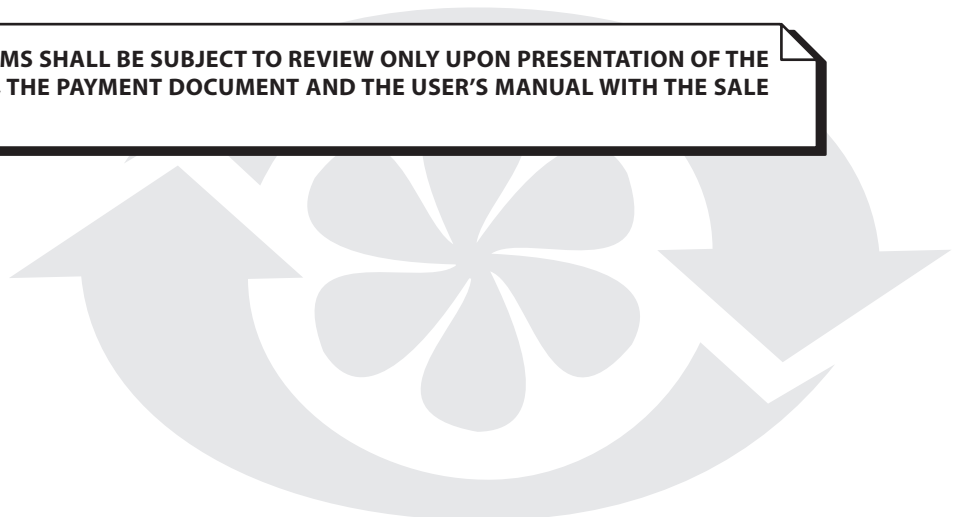

## ACCEPTANCE CERTIFICATE

<b>Product Type</b>	Control unit for the air heating unit with electric heater VENTS AOE series
<b>Model</b>	UET _____
<b>Serial Number</b>	
<b>Manufacturing Date</b>	
<p>is hereby declared ready for service.          We hereby declare that the product complies with the essential protection requirements of Electromagnetic Council Directive 2004/108/EC, 89/336/EEC and Low Voltage Directive 2006/95/EC, 73/23/EEC and CE-marking Directive 93/68/EEC on the approximation of the laws of the Member States relating to electromagnetic compatibility.          This certificate is issued following test carried out on samples of the product referred to above.</p>	
<b>Quality Inspector's Stamp</b>	

## SELLER'S INFORMATION

<b>Shop name</b>	
<b>Address</b>	
<b>Telephone</b>	
<b>E-mail</b>	
<b>Sales date</b>	
<p>This is to certify delivery of the complete control unit with the user's manual. The warranty terms are acknowledged and accepted.</p>	
<b>Customer's signature</b>	

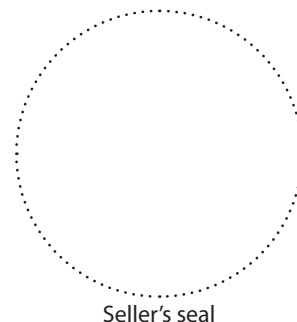

## MOUNTING CERTIFICATE

<p>The control unit UET _____ has been connected to power mains pursuant to the requirements stated in the present user's manual.</p>	
<b>Company name</b>	
<b>Address</b>	
<b>Telephone</b>	
<b>Installation technician's full name</b>	
<b>Installation date:</b>	<b>Signature:</b>
<p>This is to certify that the work specific to the control unit installation has been performed in accordance with all the applicable provisions of local and national construction, electrical and technical codes and standards. The control unit operates normally as intended by the manufacturer.</p>	
<b>Signature:</b>	

